

Scaffolds Series

NU-WAVE
SCAFFOLDING SYSTEMS

Classic

Model #550

54-5/8" Ladders, 5' Platform and Trusses

Model #660

69-1/2" Ladders, 6' Platform and Trusses

- Scaffold components made in the USA
- Easy Set Up
- Load Capacity of 1000 lbs.
- Rolls through standard door openings
- All Steel Construction
- Adjusts in 4" increments

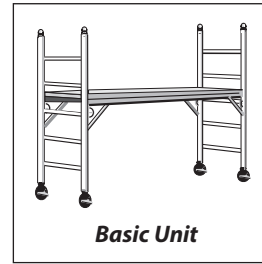

Prod#	Description	Ship Wt.
48505	550 Classic With PIC-5	128
48547	660 Classic With PIC-5	145

Elite with Locking Platform

Model #660

69-1/2" Ladders & 6' Locking Platform and Trusses

Model #680

69-1/2" Ladders & 8' Locking Platform and Trusses

- With Locking Platform
- Scaffold components made in the USA
- Easy Set Up
- Load Capacity of 1000 lbs.
- Rolls through standard door openings
- All Steel Construction
- Adjusts in 4" increments

Prod#	Description	Ship Wt.
48550	660 Elite With PIC-5	145
48570	680 Elite With PIC-5	163

Scaffold Parts and Accessories

NU-WAVE
SCAFFOLDING SYSTEMS

Guardrail Kits and Toeboards

For your safety, always use guardrails at any working height. They are recommended equipment when using any scaffold. Toeboard brackets permit you to install toeboards to help prevent workmen from knocking material off the scaffold, or accidentally stepping off. Use toeboards any time the platform height is 10 ft. or more.

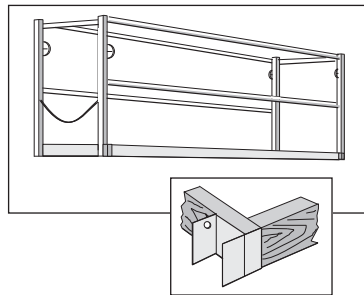

Product #	Model #	Description	Ship Wt.
48660	GK-6	Guardrail Kit—6 ft. Scaffold 2-GR2&2-GR6	68
48690	GRE-2C	Guardrail End (with Chain Midrail)	13
48695	GRE-2S	Guardrail End (with Solid Bar Midrail)	13
48710	GR-6	Guardrail Side for 6 ft. Scaffold	21
48740	GKC-6	Guardrail Kit Complete 2-GR2, 2-GR6, 4-TB100, 2-ET2, 2-TS6	74
48780	TB-100	Toeboard Bracket (4 required)	1

Outriggers

Need more height? PO-100 outriggers let you stack scaffolds three high! Remember to order an extra caster for each of the four required outriggers.

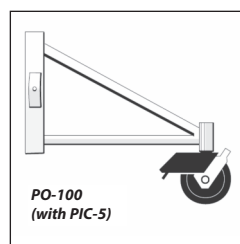

Product #	Model #	Description	Ship Wt.
48820	PO-100	20" Outrigger (Casters not incl.)	7
48825	PO-100/4	Set of 4 Outrigger (Casters not incl.)	28

Scaffold Parts and Accessories

NU-WAVE
SCAFFOLDING SYSTEMS

Ladders

The perfect way to add height to any scaffold. Platforms may be adjusted in 4 inch increments as on the basic unit.

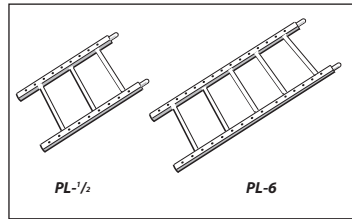

Product #	Model #	Description	Ship Wt.
48970	PL-1/2	40 inch Ladder, 3 rungs	18
48980	PL-6	69 1/2 inch ladder, 5 rungs	28

Standard Trusses

Joins the scaffold ladders and supports the scaffold platform. Features the patented "Positive Engagement Locking System" for fast, easy assembly and height adjustment.

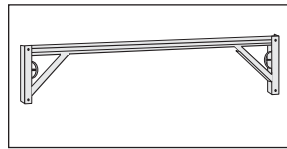

Product #	Model #	Description	Ship Wt.
48910	PT-6	6 ft. Adjustable Truss	21

Miscellaneous Parts

Keep your equipment maintained and working like new with genuine, quality replacement parts.

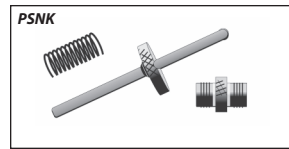

Product #	Model #	Description	Ship Wt.
49080	PSNK	Pin-Spring-Nipple Kit*	0.5

* For lock replacement

Plywood Platform

5/8 inch thick plywood with 1/32 inch galvanized banding. The banding is fixed to the plywood to provide permanent protection.

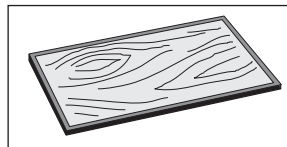

Product#	Model#	Description	Ship Wt.
49010	PP-6EL	Elite* 6 ft. (28.5" x 70.25")	27
49015	PP-6CL	Classic 6 ft. (28.5" x 70.25")	24
49020	PP-8EL	Elite* 8 ft. (28.5" x 94.25")	42

* Locking Platform

Casters

INDY CASTERS feature a unique self-adjusting locking mechanism. A streamlined lever design permits 360 degree wheel rotation.

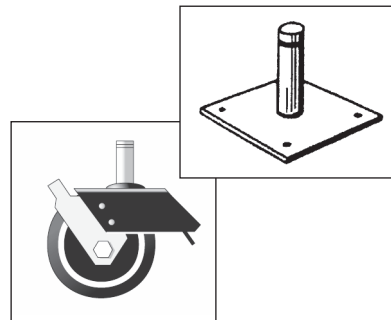

Product#	Model#	Description	Ship Wt.
48895	PBP	5" X 5" Base Plate	2
49040	PIC-5	5" INDY Caster-Swivel&Wheel Brake	5

Mini-Scaffolds

Model SU-4

4 Ft. Step-Up® Portable Mini-Scaffold

With its sturdy 1" O.D. tubular construction, 500 lb. load capacity and 50" height, the SU-4 is perfect for all low ceiling jobs. The SU-4 comes with 5" INDY All Brake Casters which permit 360 degree wheel rotation for ease of movement. Folds down to just 22" wide.



Prod#	Description	Load Cap	Ship Wt.
48035	4 ft. Step-Up Mini-Scaffold with 4 #PC54B-S" all brake casters 51.5" high x 48" long x 22" wide	500	70

Model SU-5

5 Ft. Step-Up® Portable Mini-Scaffold

Throw away those bulky, shaky ladders, A-frames and planks! Whatever job you're up to, the SU-5 will help you do it faster, safer and easier. The SU-5 is adjustable to four convenient working heights, has a 600 lb. load capacity, and features INDY All Brake Casters.



Prod#	Description	Load Cap	Ship Wt.
48037	5 ft. Step-Up Mini-Scaffold with 4 #PC54B-S" all brake casters 61.5" high x 56" long x 25" wide	600	90

Model SU-6

6 Ft. Step-Up® Portable Mini-Scaffold

By popular demand...a taller version of Nu-Wave's Step-Up Utility Work Stand! Like all of Nu-Wave's Mini-Scaffolds, the SU-6 sets up in seconds with no assembly required. Adjusts to six working heights up to six feet. Features include "high tech" cushion rubber locking swivel INDY casters and big 600 lb. load capacity.



Prod#	Description	Load Cap	Ship Wt.
48039	6 ft. Step-Up Mini-Scaffold with 4 #PC54B-S" all brake casters 72" high x 56" long x 25" wide	600	100

INDY 5 inch All Brake Caster

Virtually the same as the high-tech INDY Casters* used on full-size scaffolds, the custom 5 inch INDY all brake casters for 4 ft., 5 ft. and 6 ft. step-up mini-scaffolds enhance both durability and safety.

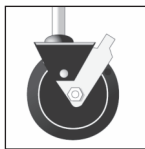

Unlocked

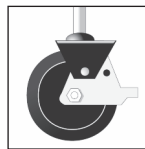

Locked

Product #	Model #	Description	Ship Wt.
48160	PC54B-S	5" diameter side all-brake caster for SU-4, SU-5, SU-6	4

*INDY Casters feature a unique, self-adjusting locking mechanism

Platforms

14 gauge solid steel platforms let you easily adjust the working height on your mini-scaffold.

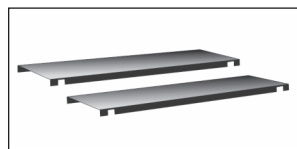

Product #	Model #	Description	Ship Wt.
48110	PP-2	Platform for SU-4	13
48300	PP-3	Platform for SU-5, SU-6	18

Drywall Carts

NU-WAVE
SCAFFOLDING SYSTEMS

Model PD-1 Residential Drywall Cart

This residential drywall cart has a streamline design, ergonomic handle, and is lightweight.

- 2000 lb. load capacity
- 17.25" wide x 47" high x 39.25" long

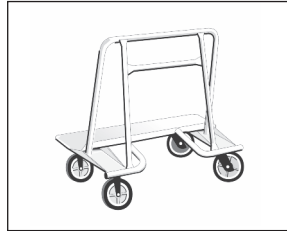

Product #	Model #	Description	Ship Wt.
49090	PD-1	Without Casters	50

Model PD-2

For most applications, this economical model is all you need to do the job. Two wheels are fixed position for straight ahead movement. Two wheels swivel for turning. Like all the other drywall carts, it's built to last with quality.

- 3,000 lb. load capacity
- 22" wide x 47" high x 43.625" long



Product #	Model #	Description	Ship Wt.
49100	PD-2	Without Casters	50

Model PD-3

The bottom tube frame on this model surrounds the entire perimeter for extra strength and durability. It may be ordered with swivel casters and optional position locks for two wheels. The compact design fits through standard doorways.

- 3,000 lb. load capacity
- 22.5" wide x 47" high x 49.75" long

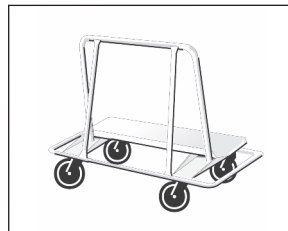

Product #	Model #	Description	Ship Wt.
49170	PD-3	Without Casters	69

Model PD-4

This model features a special inset back tube frame. It provides maximum maneuverability around tight corners or through standard doorways with four swivel casters. Optional position locks keep two wheels straight when moving one direction.

- 3,000 lb. load capacity
- 25" wide x 47" high x 49.75" long



Product #	Model #	Description	Ship Wt.
49240	PD-4	Without Casters	75